

Elfin II

High Resolution Inkjet Printer



User Manual

IMPORTANT

To ensure the best printing quality, we recommend using only our specified cartridges and the corresponding accessories. Any malfunction or poor printing quality caused by improper use of other kinds of inks or accessories will be not be guaranteed.

Safety Precautions

There is high voltage inside the machine when it is live. Maintenance or disassembly by unqualified or unauthorized person is strictly prohibited, so as not to cause any accident.

Machine must be reliably grounded by connecting the grounding wire for the machine during equipment setup. Unreliable grounding will result in machine failure that the machine cannot work normally.

Do not expose ink to direct sunlight or high temperature (35°C above). The heat of direct sunlight or high temperature will affect ink's storage life and print quality.

If you get ink spill on the eyes or skin during use, please clean your eyes or skin by clean water.

Ink leakage inside printer can result in burnout damage to the machine. Switch off the machine and unplug it from power outlet when there's ink leakage inside printer. Contact qualified service technician for test and repair.

Warning Signs

Caution: The sign “” indicates information for caution of possible damage to hardware of inkjet printer or data loss.

Attention: The sign “” indicates important notes helpful for your trouble-free operation of the machine.

Content

Introduction

Chapter One: Important Precautions for Using 06

1.1 Important Setup Precautions.....06

1.2 Important Operation Precautions.....06

Chapter Two: Setup and Installation Instructions 07

2.1 Printheads Adjustment and Installation.....07

2.1.1 Printheads Adjustment.....07

2.1.2 Single Printhead Installation.....07

2.1.3 Double Printheads Installation.....08

2.1.4 Anti-Shock Mechanism & Plate (Optional).....08

2.1.5 Bracket Installation.....09

Chapter Three: Introduction 10

3.1 Printer.....10

3.2 Technical Specifications.....12

Chapter Four: How to Use the Printer and the Check Work before/after Use 13

4.1 How to Use the Printer.....13

4.2 Check Work before Use.....13

4.3 Check Work after Use.....13

Chapter Five: Printer Operation Instructions 14

5.1 Main Interface.....14

5.2 Printing Management.....15

5.2.1 Find/Preview Data.....15

5.2.2 Start Printing / Printing Report.....15

5.2.3 Printing Delay.....15

5.2.4 Print Initial Values.....16

5.2.5 Offset Adjustment.....16

5.2.6 Stop Printing.....16

5.3 Data Management.....	17
5.3.1 New/Edit Data.....	17
5.3.2 Add Text Object	18
5.3.3 Add Production Date Object	18
5.3.4 Add Expiration Date Object	18
5.3.5 Add Image Logo Object.....	19
5.3.6 Add Counter Object	19
5.3.7 Add Shift Code Object	19
5.3.8 Add Barcode Object.....	20
5.3.9 Add dynamical text.....	21
5.3.10 Add dynamical LOGO	21
5.3.11 Delete Data or Object.....	21
5.4 System Management.....	22
5.4.1 System Setting.....	22
5.4.2 Edit Options.....	23
5.4.3 Printing Options.....	24
5.4.4 User Management	26
5.4.5 Special Features.....	26
5.4.6 Screen Touch Correction.....	28
5.5 Tools Management	28
5.5.1 Image Management	28
5.5.2 System Upgrade	28
5.5.3 System Backup	29
5.5.4 System Record	29
5.5.5 About Equipment	29
5.5.6 System Reset	30
5.6 Edit Input Method Options	31
5.7 Status Bar.....	32

Chapter Six: Care and Maintenance 33

61 Printer Care and Maintenance.....	33
62 Ink Cartridge Care and Maintenance.....	33

Chapter Seven: Troubleshooting 34

7.1 Troubleshooting for Ink Cartridge.....	34
7.2 Troubleshooting for Printer.....	35
Appendix 1: Terms and Definitions.....	36
Appendix 2: Offset Adjustment Example.....	37

Please read this manual carefully before you use this equipment.

Introduction

Thank you for your purchase of high resolution printer. We want you to get helpful information for your work with this equipment; therefore we would like to explain a little bit about how to use this machine by this user manual by the following content:

- Important precautions for use of the machine
- Introduction of printer: Parts and components of the machine
- Setup and Installation Instructions: Instructions for Equipment Setup and Cartridge Installation.
- How to use the printer and the check work before/after use of the printer: explanations of general operation and startup/shutdown.
- Operation instructions: explanations on how to new/edit data for printing, and how to adjust printer settings.
- Care and Maintenance: Care and maintenance for printer and cartridge
- Troubleshooting: Common failures occurred and solutions
- Appendix 1 - Terms and Definitions: Definitions for terms used in this document.

Please read this user manual carefully before first use of the printer for full understanding and attention of important information so that you will get maximum use from your new equipment. This will also help you have a quick reference to related sections when you have any problems during use.

Note 1: If you cannot solve the problem encountered during use, please contact us for assistance.

Note 2: The information contained herein is subject to change without notice. The amended information will be updated in user manual by new edition.

Note 3: Any machine failure or damage caused by user's negligence in following this manual will not be covered by the warranty.

Chapter One: Important Precautions for Using

Welcome to use this Printer. In order to protect your personal safety and user rights, ensure correct installation and operation, and full play of the machine, it is important that you read the precautions carefully.

1.1 Important Setup Precautions

- 1.1.1 Use exclusive power supply for the equipment. Do not share same power supply with other equipment. Besides, Installation of an additional UPS is recommended.
- 1.1.2 Mount the support in sound and stable place. Do not choose the location that will be easily affected by shock or sway.
- 1.1.3 Choose well-working conveyor belt for high print quality.
- 1.1.4 Add deflector to the printer for production line setup in order to prevent any printing object hitting the nozzle plate to cause damage.
- 1.1.5 Make sure the printer is well grounded.
- 1.1.6 Maintain the distance between deflector and printing object at 0.5-2.5mm as recommended.
- 1.1.7 Make sure to insert and remove the ink cartridge by an angle of 15 degree so as not to cause damage to the cartridge.
- 1.1.8 Make sure the setup environment is tidy and clean. Clean the dust on printer from time to time when dusty environment is unavoidable.

1.2 Important Operation Precautions

- 1.2.1 Do not poke or impact the touch screen sharply.
- 1.2.2 Do not cover up the built-in photocell. Otherwise the printer doesn't print.
- 1.2.3 Use Non-woven to wipe the nozzle plate when the print is not clear or dots are missing.
- 1.2.4 Set print delay value for best print result when print position changes (see Section 5.2.3).
- 1.2.5 Do not insert or remove ink cartridge while the machine is in printing process so as not to cause damage to the cartridge.
- 1.2.6 Do not use compressed air for cleaning the touch screen. High pressure of the compressed air will damage the touch screen.
- 1.2.7 Do not use compressed air for direct or indirect cleaning of the ink cartridge. High pressure of the compressed air will damage the nozzle plate.
- 1.2.8 Read Chapter Seven for troubleshooting when there's failure occurs. If you cannot solve the problem encountered, contact your local dealer or our after-sale service.

Note: Depending on properties, some ink cartridge may require to be removed from printer after use. Turn off the machine and remove the cartridge from printer. Wipe the printhead clean with Non-woven; cap the printhead with the designed cap for prevention of the nozzles from clogging. (Contact our after-sale service for information of ink properties.)

Chapter Two: Installation and Setup Instructions

2.1 Printheads Adjustment and Installation

2.1.1 Printheads Adjustment

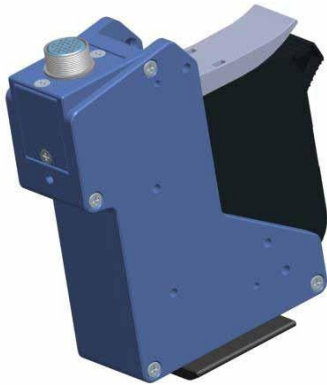

Aviation connector default status
Note: for easy operation, installation direction can be adjusted.



Remove the 3 screws on the connector, take off the plate, place it into another direction as shown on the picture, then fasten the screws back.
Connector Adjustment Finish

2.1.2 Single Printhead Installation

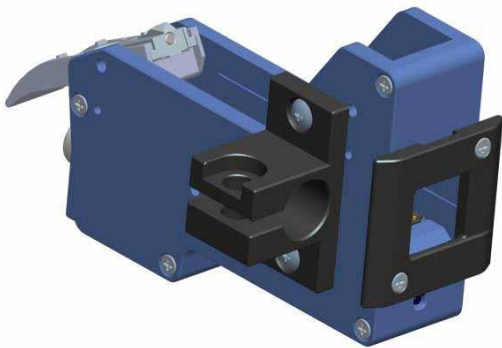

Single Printhead for Side Printing

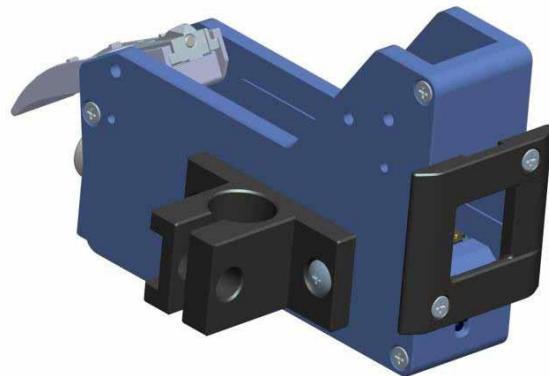

Single Printhead for Down Printing.

2.1.3 Double Printheads Installation

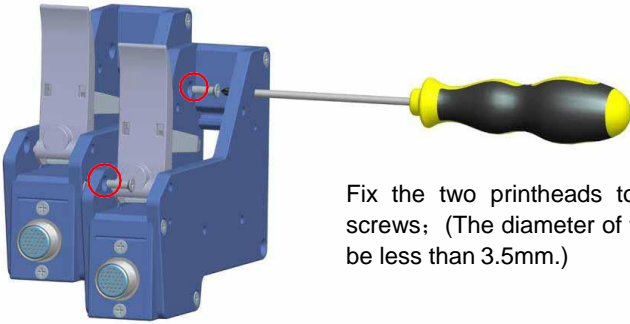

Fix the two printheads together by 2pcs M3*10 screws; (The diameter of the screwdriver needs to be less than 3.5mm.)

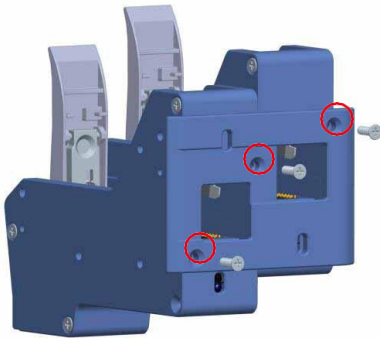

Fasten the anti-shock plate on the printheads by 3pcs M3*10 screws.

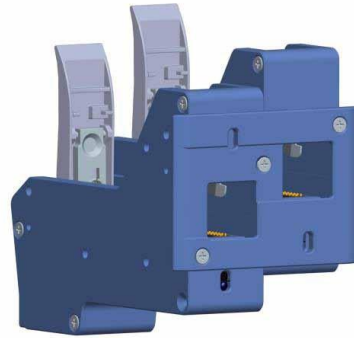

Double printheads installation finish.
Note: While install anti-shock plate, its direction can be adjusted according to production line direction.

2.1.4 : Anti-Shock Mechanism & Plate (Optional)

Note: The anti-shock mechanism and plate is optional, according to demand.

Part List

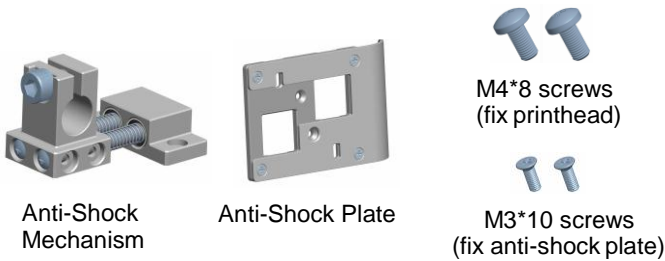

Combined Printheads

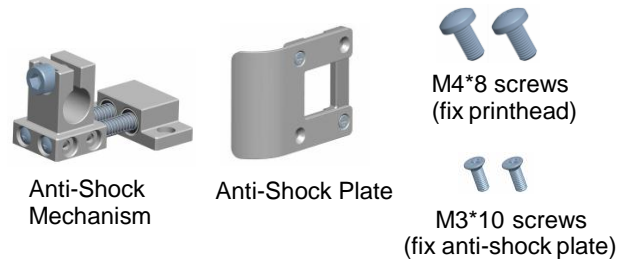

Single Printhead

Installation

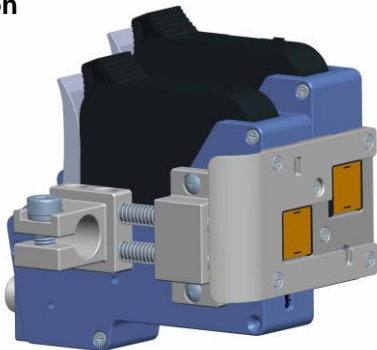

Combined printheads side printing
Note: The installation direction can be adjusted.

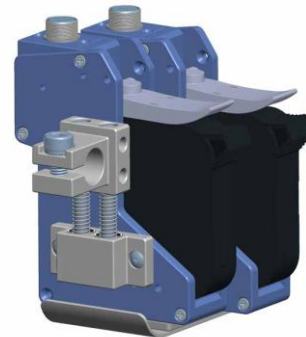

Combined printheads downward printing
Note: The installation direction can be adjusted.

Note: Installation for single printhead is the same as combined printheads.

2.1.4 Bracket Installation

Installation details, please refer to the installation video in the USB disk.

Down Printing of Single Printhead

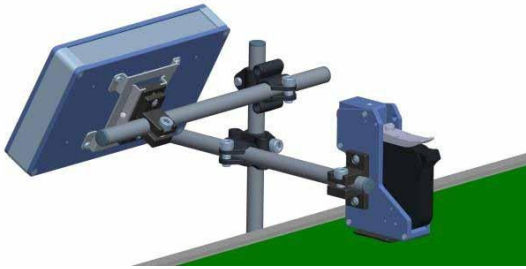

Side Printing of Single Printhead

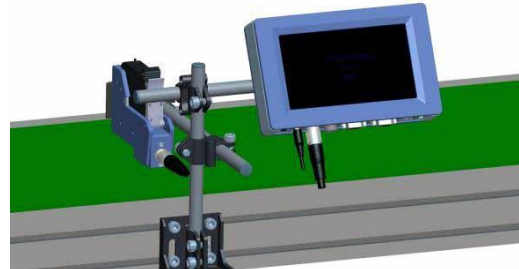

Side Printing of Double Printheads

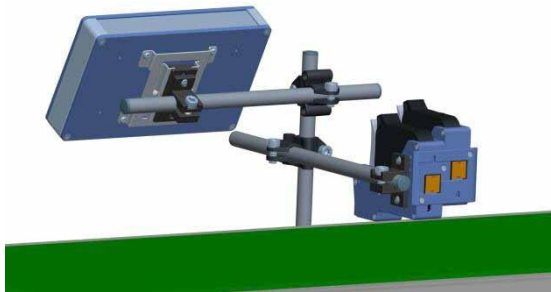

Down Printing of Double Printheads

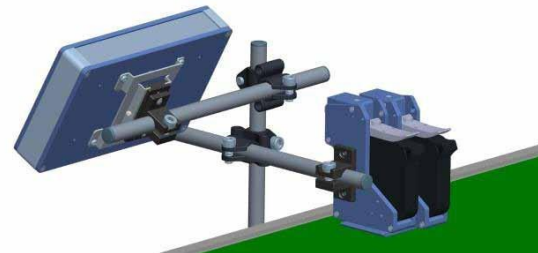

Separate Printheads Installation

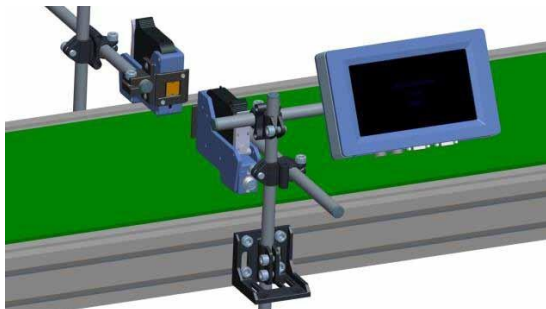

Chapter Three: Introduction

3.1 Printer

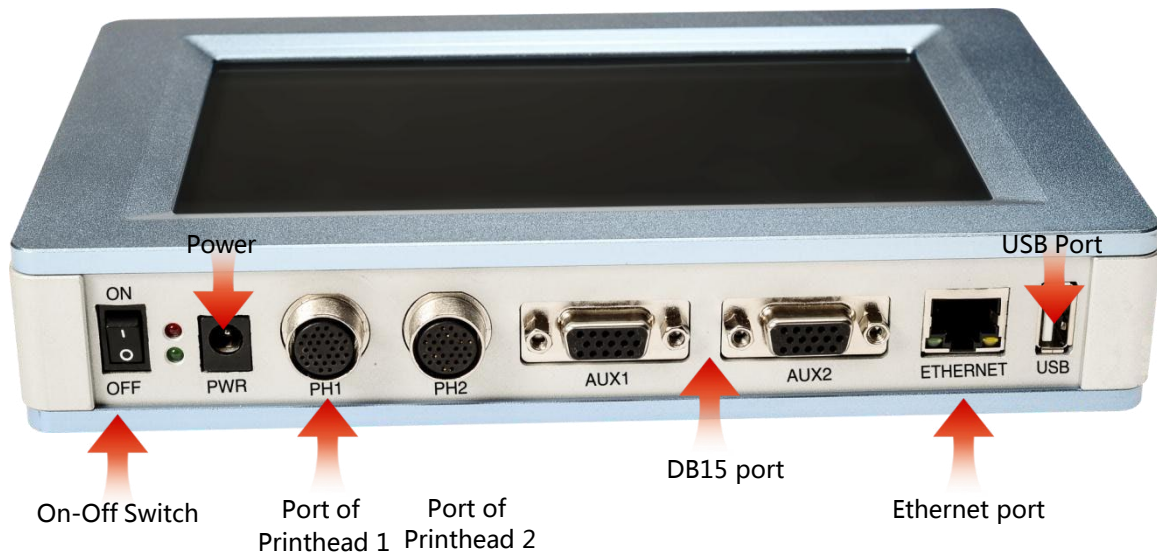

- Note:
- 1) DB15 port: can connect with external photocell, encoder, alarm kit or external data source.
 - 2) Ethernet port: can connect with Ethernet cable or external data source.
 - 3) USB port: can connect with USB or external data source.



This user manual is a universal version for printer, can be applied to single printhead mode, two printheads combined mode and two printheads separately mode, settings like below:

1. While using single printhead, settings refer to Section 5.4.3, Printing Options→A Nozzle

Maintenance →4) Printheads Selection: Select P.H. Printhead 1 or Select P.H. Printhead 2.

Note: while using build-in photocell, user can choose which one to use, the one on Printhead 1 or on Printhead 2, settings refer to Section 5.4.3, Printing Options→D Build-in

Photocell Setting→ Select P.C. P1 or Select P.C. P2 ;

2. While using double printheads combined, settings refer to Section 5.4.3, Printing Options→A

Nozzle Maintenance→Printhead Selection: Select P.H. Double Printhead Combined.

Note: 1) While using build-in photocell, user can choose which one to use, the one on Printhead 1 or on Printhead 2, settings refer to Section 5.4.3, Printing Options→D Build-in

Photocell Setting→ Select P.C. P1 or Select P.C. P2 ;

3. While using double printheads separately, settings refer to Section 5.4.3, Printing Options→A

Nozzle Maintenance→Printhead Selection: Select P.H. Double Printhead Separately.

Note: 1) While using build-in photocell, user can choose which one to use, the one on Printhead 1 or on Printhead 2, settings refer to Section 5.4.3, Printing Options→D Build-in

Photocell Setting→ Select P.C. P1 or Select P.C. P2 ;

2) While using double printheads separately, Spit function and Purging function can be set separately, steps refer to Section 5.4.3 Printing Options→A Nozzle Maintenance→

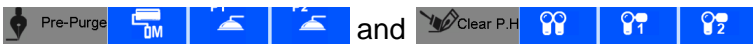

3) While using double printheads separately, Printing Direction and Channel Switch can be set separately, steps refer to Section 5.4.3 Printing Options→A Printhead Setting

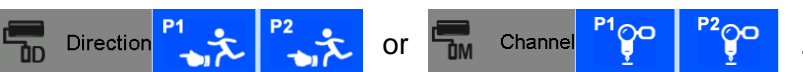

3.2 Technical Specifications

A. Performance Values

Item	Specifications	Note
Technical source	HP TIJ 2.5 Thermal Ink Jet technology	
Dimension	controller(H*W*D): 210*135*37mm/8.3*5.3*1.46inch Print head(H*W*D): 142*133*55mm/5.6*5.2*2.15inch	Including the spring mechanism
Power supply	AC 90V-240V/50-60HZ, 90W (Dedicated AC);	
Print heights	1~12.7mm	
Print speed	0~60m/min (300DPI) 0~30m/min (600DPI)	
Resolution	50~600DPI	
Print application	Barcode, alphabetic, numeric, image logos, date/time, expiration date, shift code, counter, lot-box code	
Connection Ports	1) Ethernet: 100Mb/s, Synchronized control of multiple devices via PC; 2) USB2.0: Support U-Disk; 3) DB15: For external devices like photocell, synchronizer or alarm kit connection;	
Interface	1) 7 inch 800 *480 color LCD touch screen; 2) With touch screen interface operation, easy to use; 3) Printer can work separately without PC software;	
Ink management	1. Automatically recognizes ink types, and identifies optimum printing parameters for each ink type; 2. Guarantees the using of genuine original HP ink; 3. Automatic measuring system for the usage of ink.	
Mounting	Standard side and downside printing assembly, customers can fix it flexibly;	
Product Certification	CE, FCC.	
Environment requirement	1. Working environment: -10°C~ +55°C; 10%-85%RH; 2. Storage environment: -25°C~ +80°C; 10%-90%RH.	

B. Features:

Item	Specifications	Note
Languages	Chinese, English, Japanese, French, German, Spanish, Portuguese and Russian.	
Font	Default font is Arial; allow users to load fonts they need.	
Barcode	UPCA, UPCE, EAN13, EAN8, INT25, CODE39, CODE128, EAN128, PDF417, DATAMATRIX, QR.	
Date format	Variety of date formats available	
Device's Database suport	Provide standard port of RS-232, Ethernet, easy to integrate for customers	
PC Software's Database	MS Excel, MS Access, SQL2000, SQL 2005, SQL2008	

C. Ink Solutions:









1. Support 42ml, 370ml, 350ml cartridges of HP TIJ2.5 technology;
2. Support ink of various colors: black, red, green, yellow and blue;
3. Support porous, semi-porous and non-porous substrates.

Chapter Four: How to Use the Printer and the Check Work before/after Use

In this Chapter, you will learn how to use the printer, including check work before and after use.

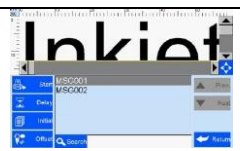
 **Note:** After printer starts, firstly set the printheads and build-in photocell, details please refer to Section 5.4.3

4.1 How to Use the Printer

Sq #	Procedure	Instructions
1	cartridge Installation	Insert cartridge into the printer stall by an angle of 15 degree, close cartridge clip to secure. (see 2.3 Cartridge Installation)
2	Turn on printer	Connect power adapter to printer power input, switch on power, printer enters initialization startup. 
3	Main Interface - Printing Management	After initialization startup, "main interface" appears (see Section 5.1). Click  to enter "Printing Management" (see Section 5.2). 
4	Select data - Start printing	Select a file on data list, click  to Start printing. 
5	Printing report	When printing starts, the button change to the icon  for stop printing, meanwhile a printing report appears. 
6	Stop printing	Click  to stop printing, printing report exits, and the button returns to "Start printing" status. 
7	Switch off	Exit printing, and switch off power.

4.2 Check Work before Use

Sq #	Item	Check Work
1	Printer support	Is the support securely mounted?
2	Printer position	Is the printer orientation correct? Is the nozzle plate parallel to printing object? Is the throw distance controlled within 0.5-2.5mm?
3	cartridge	Is the cartridge wiped clean? Has the cartridge been installed to printer?
4	Power input	Is the printer input voltage normal?
5	Printer status	Check status bar, is the equipment status normal?





4.3 Check Work after Use

Sq #	Item	Check Work
1	Printer Power Status	Is the printer power switched off?
2	cartridge	Is the cartridge removed from printer and wiped clean and printhead capped?

Chapter Five: Printer Operation Instructions

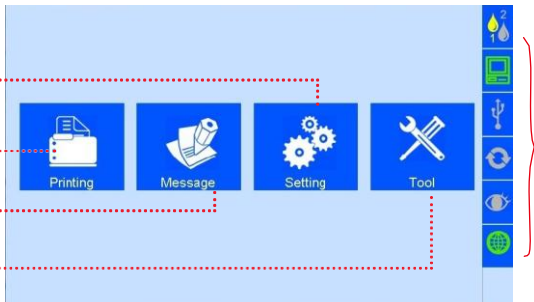
This chapter explains how to operate printer interface, including Printing Management, Data Management, System Management, Tools Management, and Status Bar.

5.1 Main Interface

<p>Switch on power, printer starts initialization startup. After initialization startup, "main interface" appears .</p>	 <p>Setting Management Printing Management Message Management</p> <p>Printing Message Setting Tool</p> <p>Status bar</p>	
	<p>Printing Management</p>	<p>To find and preview data, start/stop printing, set printing delay value, and set printing initial values (see Section 5.2).</p>
	<p>Message Management</p>	<p>To Find/Preview, File-new, Edit, Delete data (see Section 5.3).</p>
	<p>Setting Management</p>	<p>To manage system setting, editing options, printing options, user authority, and screen correction setting (see Section 5.4).</p>
	<p>Tools Management</p>	<p>To manage image logo, system upgrade, system backup, system record, equipment default restoring, system resetting (see Section 5.5).</p>
<p>Status bar</p>	<p>Display information of ink, equipment, USB, encoder, external photocell, and Ethernet status (see Section 5.7).</p>	

5.2 Printing Management

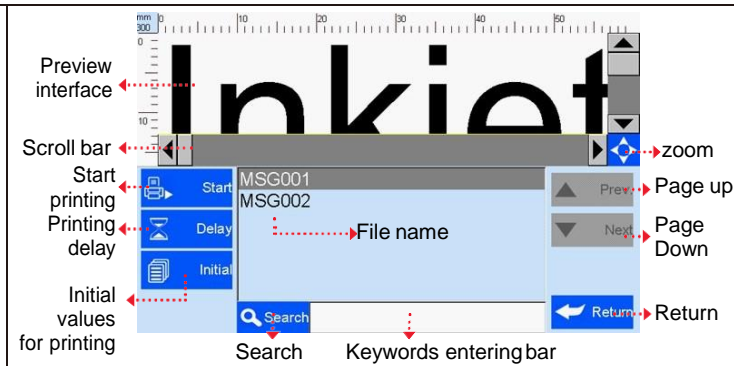
<p>Click  on main interface to enter printing management.</p>	 <p>Labels in the screenshot: Preview interface, Scroll bar, Start printing, Delay, Initial values for printing, Search, Keywords entering bar, zoom, Page up, Page Down, Return.</p>
--	---



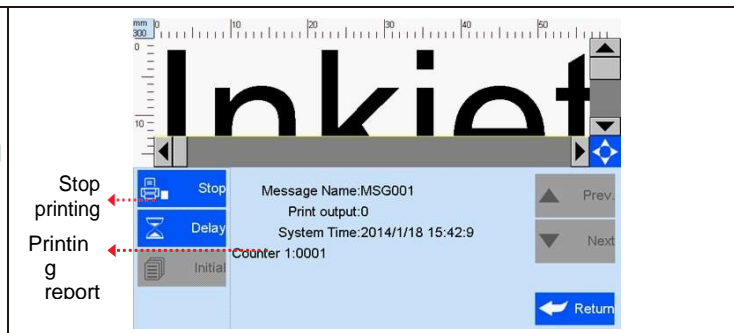

5.2.1 Find/Preview Data

A. Find data	Find by Pageup/Pagedown/keywords.
B. Preview data	Preview data by locating or selecting a file of data to display on preview interface; ddata located/selected will be displayed in sequence on preview interface.
Note: Drag the scroll bar horizontally to view the data when it exceeds the screen horizontally.	

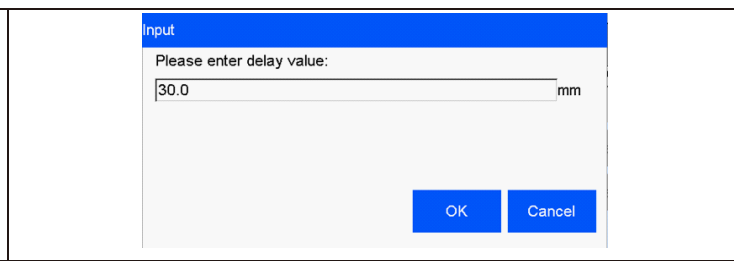

5.2.2 Start Printing / Printing Report

<p>Click  button to start printing. When printing starts, a printing report appears. Printing report: It is the timely record of printing in process, including data file name in process, print output quantity, counter value, shift code, system time. The printing report exits when printing stops.</p>	 <p>Labels in the screenshot: Stop printing, Delay, Printing report, Message Name:MSG001, Print output:0, System Time:2014/1/18 15:42:9, Counter:1:0001.</p>
--	---

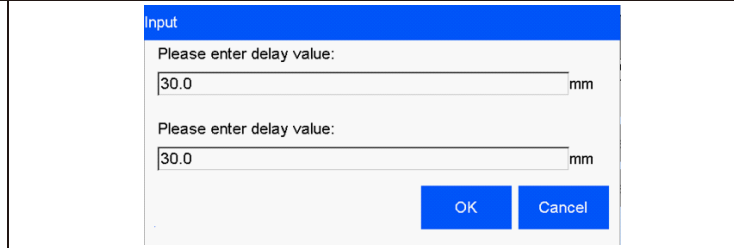
5.2.3 Printing Delay

<p>Click , printing delay setting interface appears .  See Appendix 1: Terms and Definitions 1 for more information.</p>	
<p>Note: While the printheads setting is separately as , the print delay value need to be set independently.</p>	
A. Printing delay default value: 30mm;	
B. Printing delay value range: 0.0-999.9mm;	
C. It is allowed to set printing delay value during printing process: the newly set value becomes valid for immediately next printing.	
D. Printing delay value for each message are independent from one another, the delay setting for current data file will not affect another data file.	

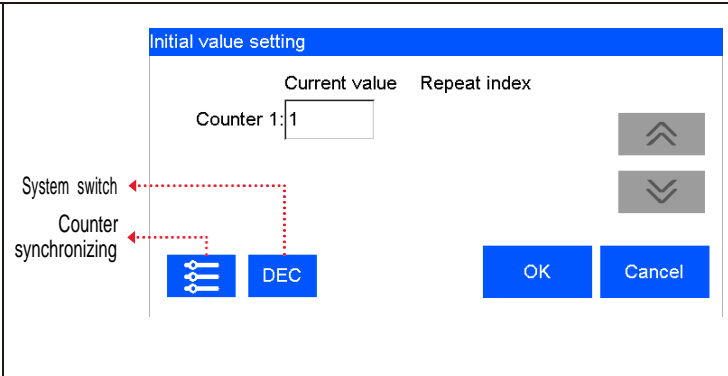
5.2.4 Print Initial Values

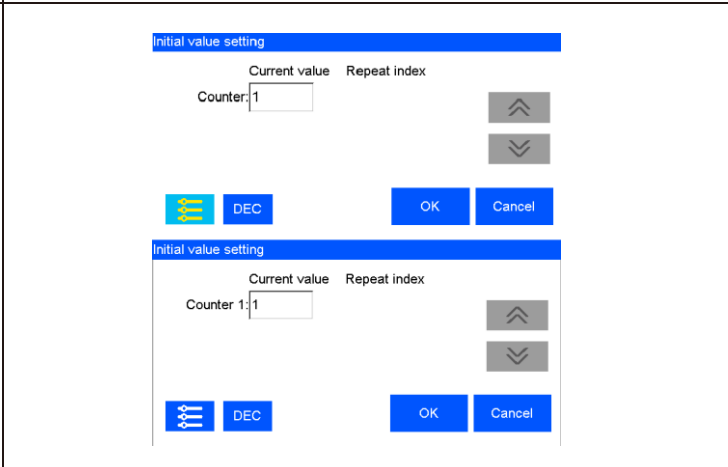
<p>Click , the interface of initial values setting and repeated index value checking appears.</p> <p>System switch DEC-10 decimal (0-9) H36-36 hexadecimal (0-Z) The Generic Binary is editable; See5.4.2</p>	
<p>Counter Synchronizing: when multi counter included in the same file, click , then all counters' current value will be synchronized to counter 1's current value.</p> <p>After confirmed, a dialog box will display the counters' setting, user can set the counter's begin/end/step/repeat number and the binary regulation.</p>	

5.2.5 Stop Printing

<p>Click  to stop printing and exit printing report, return to Start Printing status (see Figure 2).</p>
<p>Note: Printer automatically stops printing when there is case as power-off, out of ink, alarming etc.</p>

5.3 Data Management



Click **Message** on main interface to enter data management interface

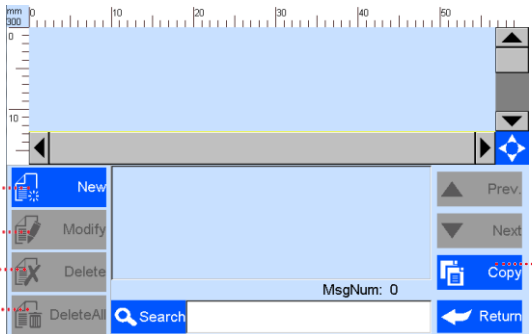

New
Modify
Delete
Delete all

Copy

5.3.1 New/Edit Data

Click **New** or **Modify** on data management interface to enter data edit interface.

A. New: text, counter, shifts, production data, expiration data, image logo, barcode, dynamic text, dynamic logo, device information, string;

B. Edit: data in printing process cannot be edited;

C. File name: maximum 15 characters, empty file name or repeated file name are not allowed.

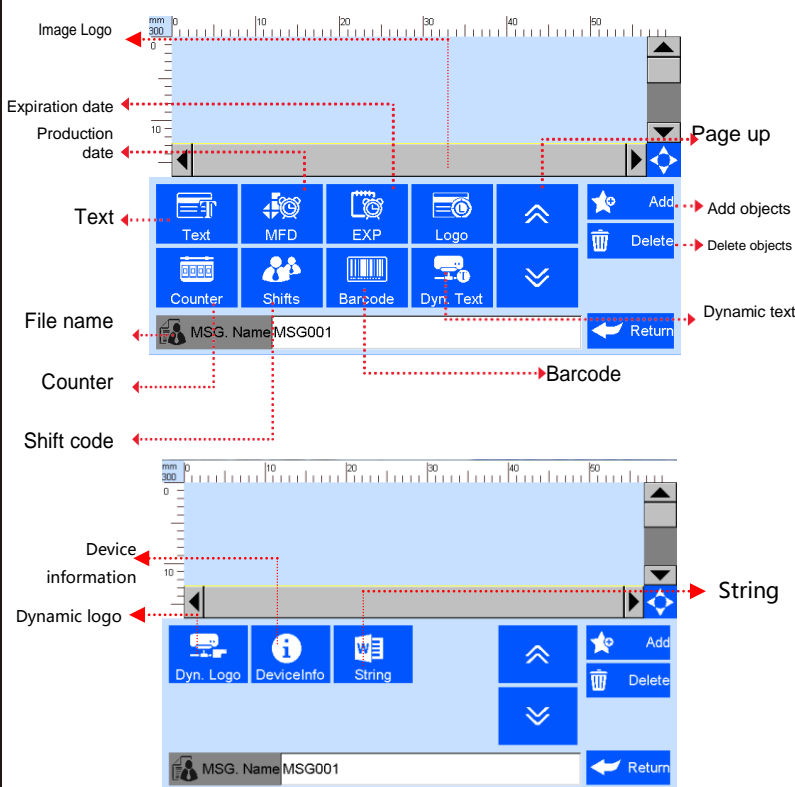



Image Logo
Expiration date
Production date
Text
File name
Counter
Shift code
Device information
Dynamic logo

Page up
Add objects
Delete objects
Dynamic text
Barcode
String







Click **Return** to save data when finish editing, a check box appears to ask "Are you sure you want to save the message? Cancel, Yes, No"

If you click "**Cancel**", the machine will remain on editing interface.



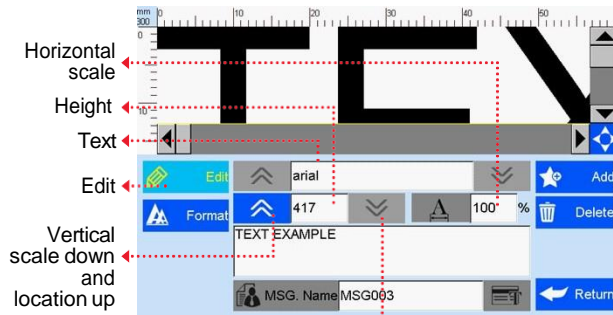

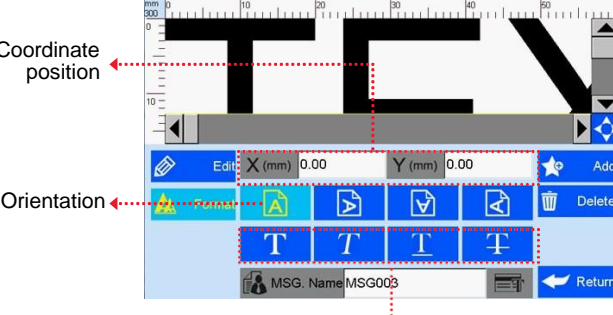
Note: "MSG001" is default data in system. The system allows maximum 500 files of data (including default "MSG001"); The system does not save empty or error messages.



5.3.2 Add Text Object

<p>Click  Text to add text object.</p> <p>Click  Edit to enter text editing interface:</p> <p>A. Font: including the default one, totally support 2 fonts at same time, the default one and one alternative font.</p> <p>B. 16-417(adjust freely within the scope of 1-25.4mm);</p> <p>C. Text horizontal scale: 1-300%;</p> <p>D. Text content cannot exceed 25 characters.</p>	 <p>Horizontal scale</p> <p>Height</p> <p>Text</p> <p>Edit</p> <p>Vertical scale down and location up</p> <p>Vertical scale up and location down</p>
<p>Click  Format to enter text adjustment interface.</p> <p>E. Coordinate location: adjustable range for X axis 0-3000mm; for Y axis, 0-25.4mm.</p> <p>F. Text orientation: 0°, 90°, 180°, 270° Four orientations adjustable.</p> <p>G. Font effects: bold, italy, underline, strikethrough, four effects adjustable.</p>	 <p>Coordinate position</p> <p>Orientation</p> <p>Font effect</p>
<p> Note: Please refer to this Section (Section 5.3.2) regarding how to add objects as “production date”, “expiration date”, “image”, “counter”, “shift code”, “dynamical text”, “dynamical logo”, but the content of “production date”, “expiration date”, “counter”, “shift code”, “dynamical text”, “dynamical logo” cannot be revised or adjusted directly when you add, and the font, height, content and font effect of “image” “dynamical logo” cannot be revised directly. There is no option of horizontal scale “” for “image”, “barcode”, “dynamical logo”.</p>	

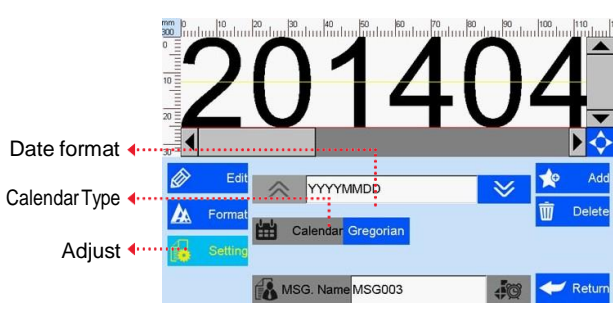
5.3.3 Add Production Date

<p>Click  MFD to add object “production date”.</p> <p>Click  Setting to enter date format setting, choose a format by arrow up and down, Gregorian and Hijri available.</p>	 <p>Date format</p> <p>Calendar Type</p> <p>Adjust</p>
---	--



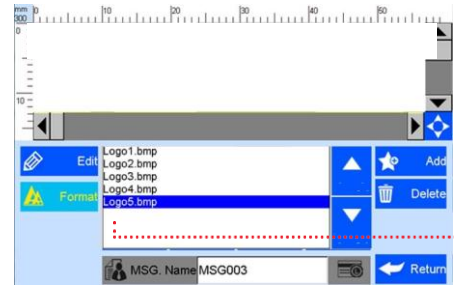
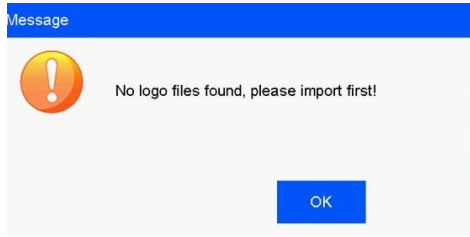

5.3.4 Add Expiration Date

<p>Click  EXP to add object of expiration date.</p> <p>Click  Setting to enter date format setting and days to expire (scope: 0–9999), Gregorian and Hijri available.</p>	 <p>Days to expire</p> <p>Calendar Type</p>
---	---



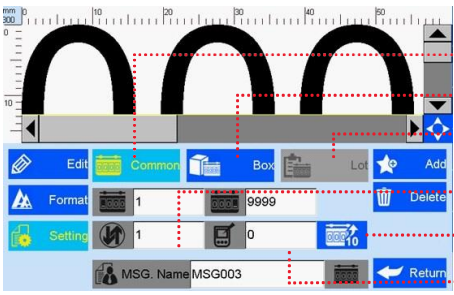

5.3.5 Add Image

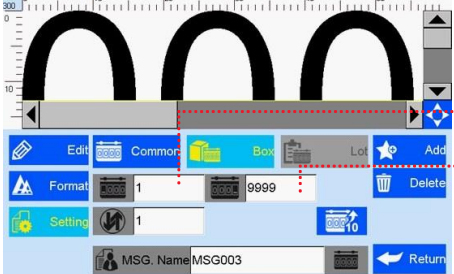
<p>Click  to add object image.</p> <p>Select a logo on file list by page up and down .</p>	
<p>Note: When there is no image file found, a message box appears to prompt image import .</p> <p>See Section 5.5.1 Image Management for image import.</p>	





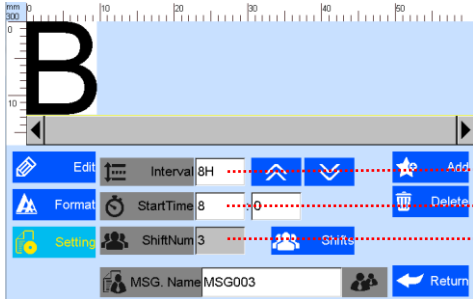

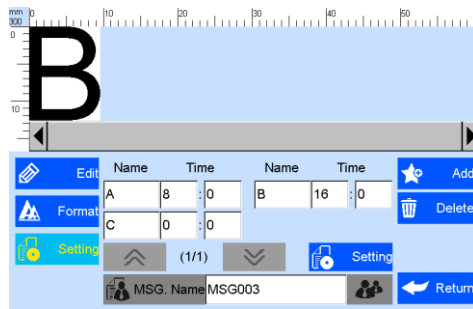

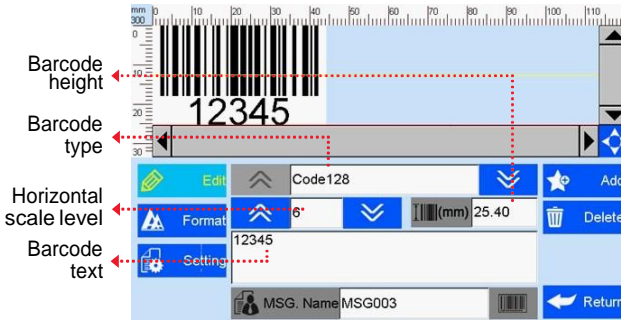

5.3.6 Add Counter

<p>Click  to add object counter.</p> <p>Click  to for option of common counter, box number, lot number.</p> <p>A. Click  for common counter setting: minimum value, maximum value, stepping value, repetition number.</p>	
<p>B. Click  and  for option of box number and lot number setting: minimum value, maximum value, stepping value for box number and lot number .</p> <p>Note: There is no repetition number for box number or lot number.</p>	



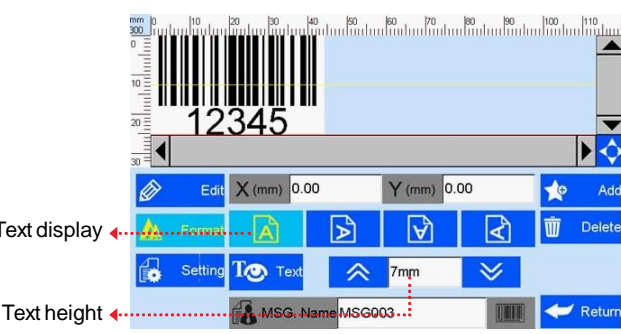
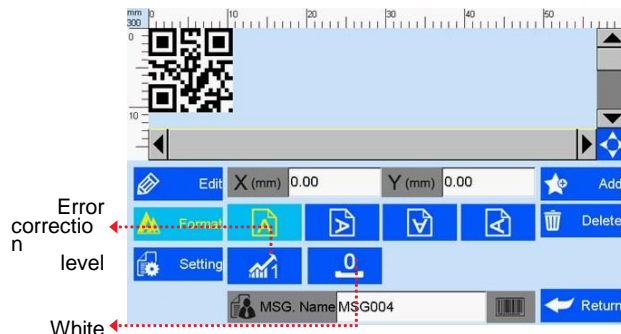

5.3.7 Add Shift Code

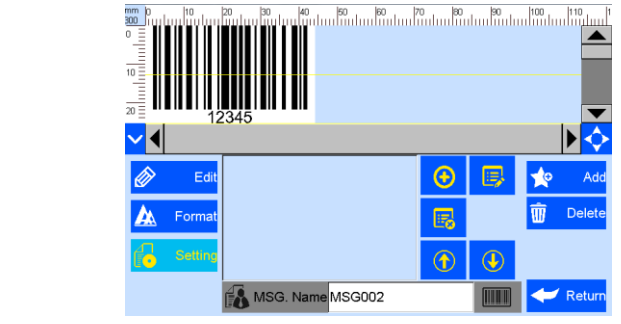
<p>Click  to add "shifts code".</p> <p>Click  enter the setting interface: can set shifts interval, start time and shifts numbers.</p> <p>A. Shifts Interval: 9 options: 0、0.5H、1H、2H、3H、4H、6H、8H、12H , each option makes a day to the responding shifts number. Such as: interval value 8H, means 3 shifts per day.</p>	
<p>B. Start time: set the time for the first shift.</p> <p>Note: in 24-hour time system.</p>	
<p>C. Shifts: set shifts numbers.</p> <p>While interval value is 0, shifts can input freely from 2-48.</p>	
<p>D. Click  班组 to view the detailed information.</p> <p>E. Shift: can set the shift name, time.</p> <p>F. Shift name: maximum 5 characters.</p> <p>G. Shift time: can set different time, shifts will change according to time.</p>	

5.3.8 Add Barcode

<p>Click  to add object "barcode".</p> <p>A. Click  to enter barcode edit: Barcode type, horizontal scale level, barcode height, barcode text .</p>	
<p>B. Click  to enter barcode adjustment: coordinate location, text orientation, text display/hide, text height, error correction level, white space level . Note: Setting options may differ depending on different barcode types.</p> <p> Text : Text display;</p> <p> Text : Text hide;</p> <p> : error correction level;</p> <p> : white space level.</p>	 
<p>C. click  enter barcodes setting interface: User can create, edit and delete data sources in the barcode content. The data sources including 9 objects: text, production date expiry date, counter, shifts, dynamic text, device info, string and carriage return. After create a new object, its name will show up in the list, user can sort the objects by up and down arrows.</p>	

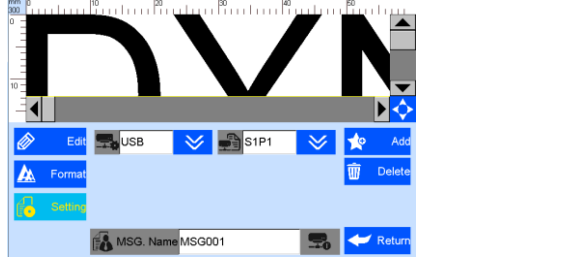
5.3.9 Add dynamical text

<p>Click  to add dynamic text.</p> <p>A. Click  to the interface of dynamical text setting with the way of dynamical transmission path or communication protocol .</p>	
<p>B. Scan printing Port is USB, selection modes are: S1P1 : scan one while printing one S1PN : scan one while printing multiples, print to next scan data SNPN : scan multiples while printing multiples, can repeat set the print times; SGPN: Fix scan numbers and print numbers, can repeat set print times and scan numbers.</p>	

5.3.10 Add dynamical LOGO

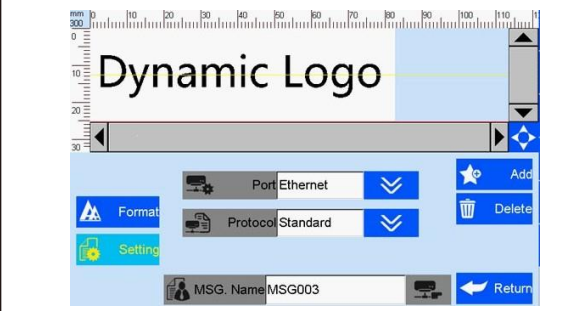
<p>Click  to add dynamical LOGO. See the picture beside.</p> <p>Note: pls refer to 5.3.9 of adding dynamical text, set the data transmission path communication protocol.</p>	
--	--

5.3.11 Add Device Information



Clip **DeviceInfo**, add device information;



Clip **Setting**, enter device information setting interface, can choose device name and device SN No.

Device name can be defined by entering 2.4.5 user management, device SN No. cannot be changed.

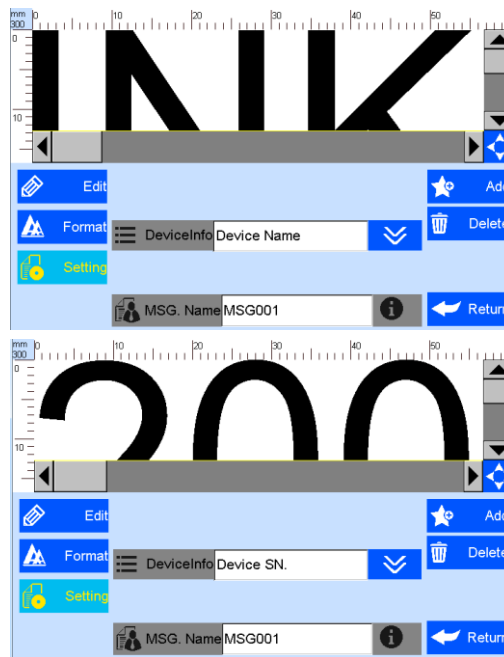

5.3.12 Add String



Clip **String** to add string.



Clip **Setting** to enter the string setting interface. The system default can add 5 different strings. One data allows maximum 20 string objects, each string of character maximum number is 75.

Note: when add one same string object, other same strings will be modified automatically while modify one of string.

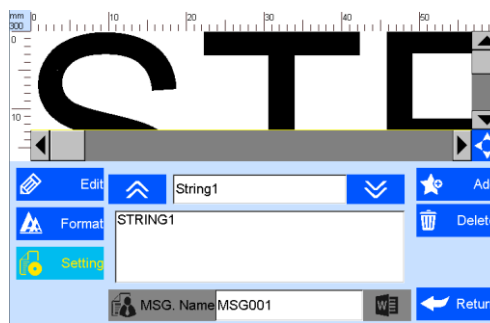

5.3.11 Delete Object or Delete/Import/copy Data

<p>Select an object on data editing interface, click  Delete to delete the object, a dialog box appears to prompt if you are sure that you want to delete.</p>	
<p> Select a file on the list on data management interface, click  Delete to delete the file, a dialog box appears to prompt if you are sure that you want to delete . Note: data in printing process cannot be deleted.</p>	
<p>Click  Import in FileManagement interface, it will import all files saved in U disk under defined route. User will be prompted if same name already existed. Before import, insert the U disk firstly.</p>	
<p>Select  Copy a file and click in File Management interface, the same message will be copied and saved as the same name with "C1" suffix, for example: MSG002's copy will be named as MSG002C1.</p>	

5.4 System Management

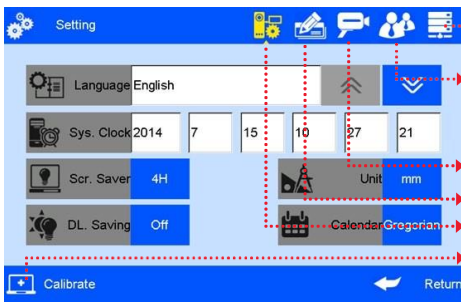
<p>Click  to enter system management.</p>	 <p>Special Features User management Printing options Editing options System setting Screen correction</p>
--	--

5.4.1 System Setting

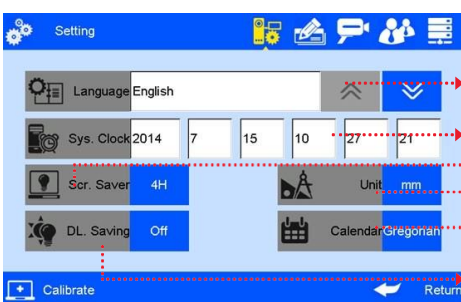
<p>Click  on system management interface to enter system setting .</p>	 <p>System Language System time Screen saver time unit Calendar Type Daylight saving time Calibrate</p>
---	---



A. System language	Standard language in delivery country as default language.
B. System time	Manufacture time as default time, can be set by user.
C. Screen saver time	<p> see Appendix 1: Terms and Definition 3.</p> <p>1) System default 4 hours, 4 options for changeover: 0.5 hour、 2 hours、 4 hours、 off (8 hours) ;</p> <p>2) If screen saver is optioned OFF, screen enters standby status if inactive for 8 hour.</p> <p>3) Screen becomes active when there's alarm or error.</p>
D. unit	Switch between mm and inch.language in delivery country as default language.
E. Daylight saving time	Three modes for setting: OFF, European summer time, US summer time.
F. Calendar Type	two modes available: Gregorian and Hijri.Default setting is Gregorian; System time will be changed according to the calendar setting.

5.4.2 Edit Options

Click  on system management interface to enter edit options setting interface.

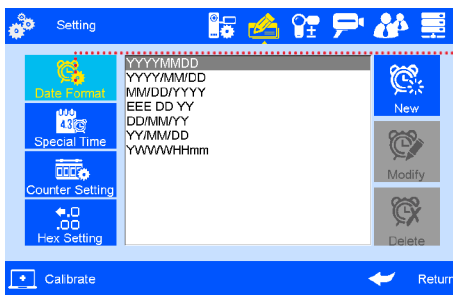
A. Click  to enter production date and expiration date format setting.
 Note: six common date formats default, forty-four more formats addable for user. The six default date formats not editable and cannot be deleted.



Click  or  in date format setting interface, new or edit date format, date format edit interface appears.

Note:
 Year/Month/Hour have 3 hex options: decimal/26 hex/36 hex, before operating first need to select hex and then the date format.



- YYYY** Year, options are: **YYYY** ---4-digit, **__YY** ---last 2 digit, **__Y** ---last 1 digit
- MM** Month, options are: **1-12** ---digit, **1-9-En** ---Jan to Sep is 1-9, and then O/N/D, **M** ---abbreviations, **M** ---full English
- HH** Hour, options are: **24H** --24 hours system, **12H** ---12 hours system

B. Click  to enter special time setting.
 see [Appendix 1: Terms and Definitions 4, 5.](#)

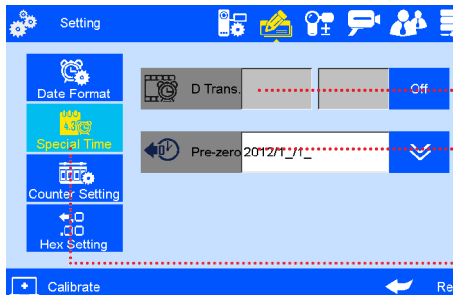

- Date transition time setting: system default normal zero o'clock as date transition time to next date, users can set different time as date transition time.
- Pre-zero in date/time: four options: OFF, empty preposition, empty postposition, centered without zero. (e.g. 2012/05/09, 2012/_5/_2, 2012/5/_2_, 2012/5/2).

C. Click  to enter counter setting

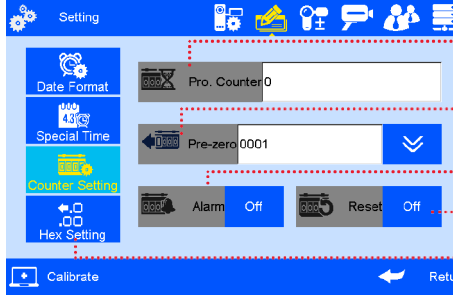

- Production counter: setting extent: 0~99999999.
- Pre-zeros: four options: OFF, empty preposition, empty postposition, centered without zero (e.g. 0001, __1, 1__, 1).
- Counter alarm: ON or OFF option. When counter alarm is turned ON, the machine will stop printing, sound alarm and prompt message that print number reaches maximum value.
- Counter reset: ON or OFF option. All counters will start from initial values if the counter reset is turned ON. The printing value will continue with the last one if the counter reset is turned OFF.

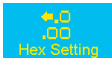
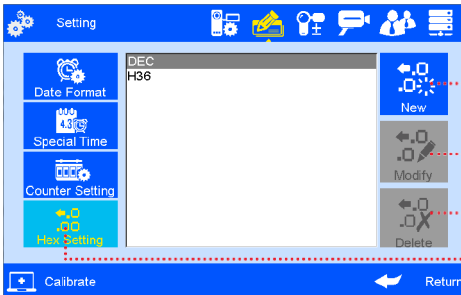
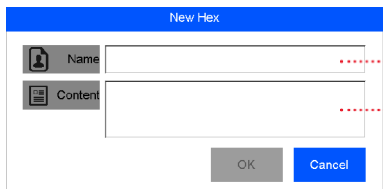

<p>D:clip  ,enter the system setting interface.</p> <p>The system can be new, modified, and deleted, system default: DEC-10 decimal (0-9) H36-36 hexadecimal(0-Z) It can't modify or delet the default system</p>	
<p>New and edit the system</p> <ol style="list-style-type: none"> 1. Can import the system name by yourself, but only allow three letters and figures. 2. System content: can import Arabic numerals 0-9, 26 uppercase letters (A-Z) or lowercase letters(a-z) 	

5.4.3 Printing Options

Click  on system management interface to enter printing option setting.

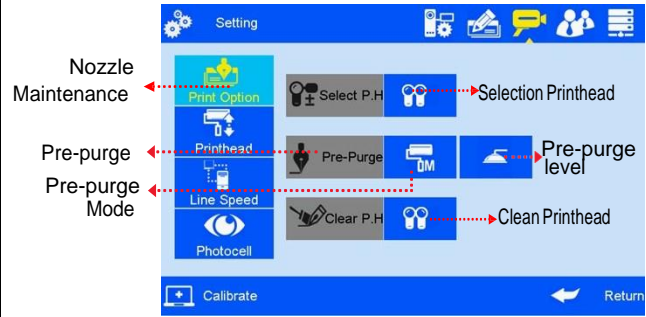
Click , to enter nozzle maintenance setting.





Note: 1) Pre-purge Mode: 2 modes:  both right & left nozzles;
 the working nozzles only.



2) Pre-purge: four shifts: OFF, low, medium, high. see the following figures:

 --Off;



 --Low;

 --Medium;

 --High

While the printheads work separately, can set single printhead by  printhead 1 or  printhead 2.

3) Clean Printhead: Spray 300 rows of ink dots at one time. This function is invalid while printer is printing

While the printheads work separately, can clean single printhead by  printhead 1 or  printhead 2.

4) Printhead Selection: 4 choices: printhead1、printhead 2、double printheads combined、double printheads separately.

 --Printhead 1;

 -- Printhead 2;

 -- Double printheads combined;

 -- Double printheads separately.

 see Appendix 1: Terms and Definitions 6, 7.

B. Click  to enter printhead Setting.

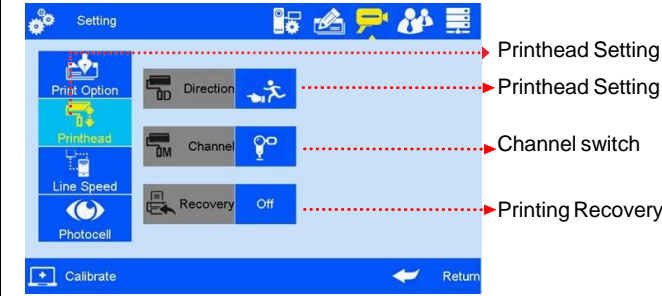



Note: 1) printing direction: system default from left to right.
 Four directions optional: left-to-right, right-to-left, mirror sides of left-to-right and right-to-left, see figures as follows:

 -- Left-to-right;

 -- Right-to-left;

 -- Mirror side of left-to-right;

 -- Mirror side of ight-to-left



While the printheads work separately, can do single setting for  printhead 1 or  printhead 2.

2) channel switch: Left channel, Right channel, Dual channel, see the figures as follows:

 -- Left channel;

 -- Right channel;

 -- Dual



While the printheads work separately, can do single setting for  printhead 1 or  printhead 2.

 see Appendix 1: Terms and Definitions 8.

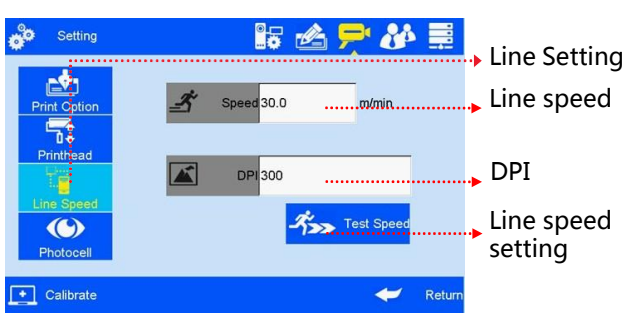



Click , to enter production line Setting.
 Line speed: system default 30m/min;
 Adjustable scope 1~150m/min;
 DPI: system default 300DPI;
 Adjustable scope 50~600DPI.

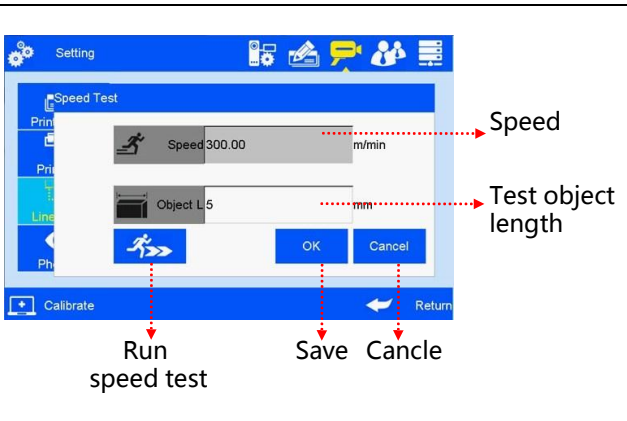

Click  on line speed setting interface to run speed test.

 Line speed test: input test object length 0~3000mm, click  to enter speed test interface, then start production line, put test object onto production line, the photocell will be sensing the object, and the machine will calculate line speed automatically. Click  to save current speed test result.



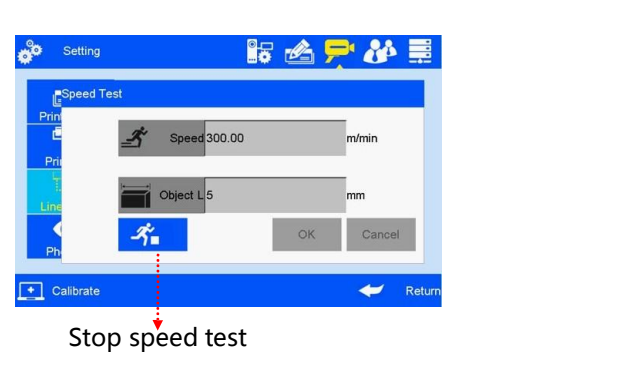

Click  current speed test value will not be saved. If test repeated, system will take average value of multiple results. Click  to stop speed test, and click  or  to save or give up test result.

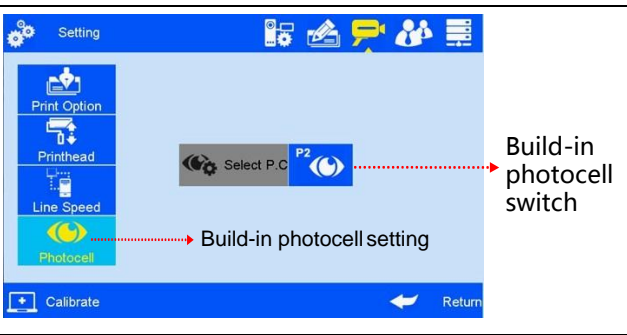

Note: if an encoder is connected, system can detect it automatically, and switch line speed interface to encoder DPI setting interface, in this case user cannot set the line speed.

D.Click , enter the build-in photocell setting.



Note: 1) Build-in photocell setting: can choose to use the one on  Printhead 1 or  Printhead 2.

Note: setting can not be adjusted while printing.

5.4.4 User Management

Click  on system management interface to enter user management (see Figure 37).

A. Device name: can be defined, the maximum is 15 characters.

B. User permission management switch: system default OFF. A login dialogue box requests user name and password for access to operation of the printer when machine power is switched on.

C. User name: different names for different access permission. Administrator is of best authority, with access to all settings including password modification. Engineer is with access to data management and printing management; and operator is with access to printing management only.

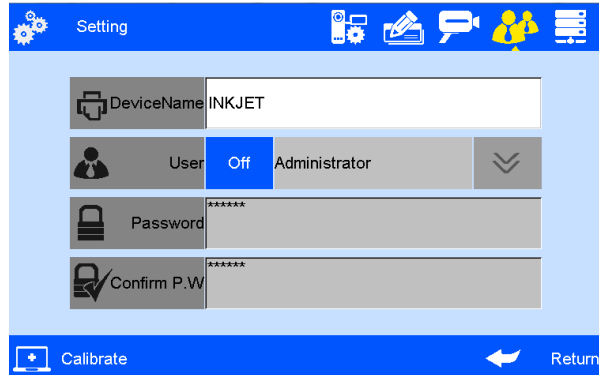

D. Password and password confirmation: administrator creates user name and set password. Maximum 15 characters for password.









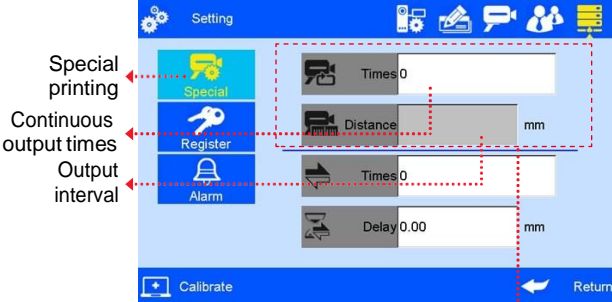
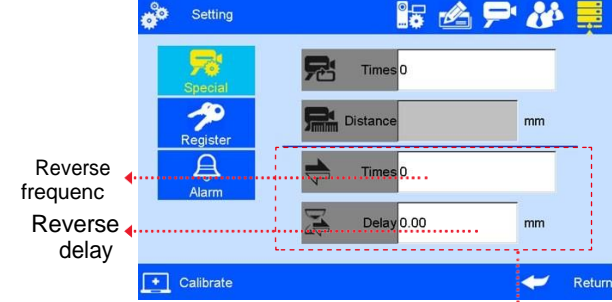

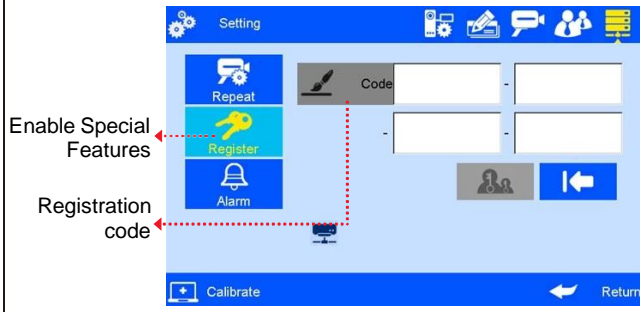
The screenshot displays the printer's user management interface. The top bar is blue and labeled 'Setting'. Below it, there are four input fields: 'DeviceName' (value: INKJET), 'User' (dropdown menu with 'Off' selected and 'Administrator' visible), 'Password' (masked with '*****'), and 'Confirm P.W.' (masked with '*****'). At the bottom, there are two buttons: 'Calibrate' and 'Return'.

Note: Please contact local dealer or our company for printer unlocking when you forget administrator password.

5.4.5 Special Features

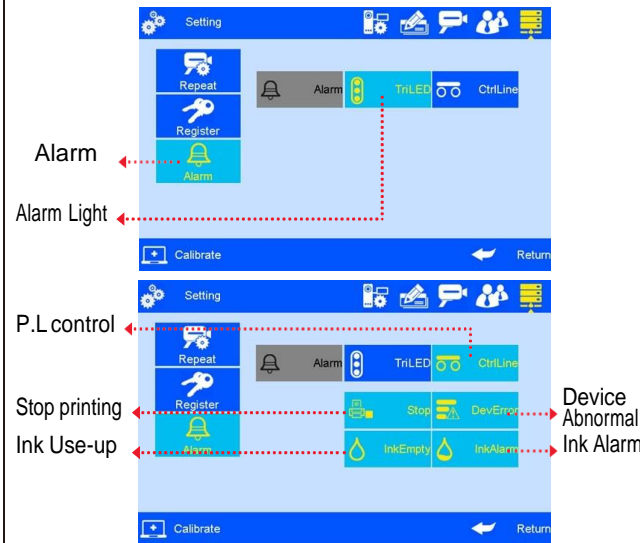
<p>Click  on system management interface to enter "Special Features" setting.</p>	
<p>A. Click  to enter "Special printing" setting .</p> <p>Continuous printing:</p> <p> See Appendix 1: Terms and Definitions 9 for more information.</p> <p>1) Continuous output times: system default 0 (OFF). Adjustable scope 0~9999. Note: 0 is equal to OFF; 9999 equal to infinite.</p> <p>2) Output interval: system default OFF, adjustable scope 0~999mm.</p>	 <p style="text-align: center;">Continuous printing</p>
<p>Bidirectional printing:</p> <p>from left to right; from right to left</p> <p>1) Reverse frequency : printing direction can be reversed automatically when the system senses the set printing times. For example, the set printing times is 3, when it is finished from right to left, printing direction will change into left to right automatically, vice versa. system default value: 0 (off) adjustable extent: 0 -9999</p> <p>2) Reverse delay : printing delay according to the set direction system default value: 0 (off) adjustable extent: 0 -999.9 it should be set before printing not during printing process</p> <p>Note: normal delay (from right to left) set in the printing interface. see: 5.2.3; This function is only suitable for the model of stitched printheads and single printhead.</p>	 <p style="text-align: center;">Bidirectional printing</p>

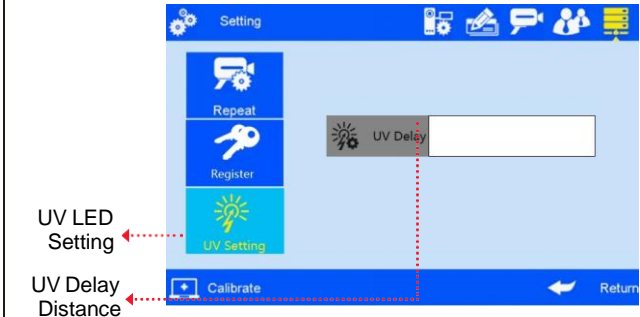
<p>B. Click  to enable “Special Features”.</p> <p>Note: Enable special features by registration code.</p>	 <p>Enable Special Features</p> <p>Registration code</p>
<p>C. Click  to do Alarm settings. User can choose Alarm Light or Production Line Control.</p> <p>Alarm Light: operation please refer to above picture.</p> <p>Production Line Control:  Stop Printing;  Device Abnormal;</p> <p> Ink Use-up;</p> <p> Ink Alarm;</p> <p>These options can be multi-selected. When the above situation happen, printer will transfer the error signal to the production line via DB15 ports, user can set the production line reaction like stop or etc.</p>	 <p>Alarm</p> <p>Alarm Light</p> <p>P.L control</p> <p>Stop printing</p> <p>Ink Use-up</p> <p>Device Abnormal</p> <p>Ink Alarm</p>
<p>D. Press , entering UV setting interface</p> <p>Note: Can set the UV delay distance; Adjustable scope 0-3000mm.</p>	 <p>UV LED Setting</p> <p>UV Delay Distance</p>

5.4.6 Screen Touch Correction

Click  on system management interface to enter screen touch correction.

Note: Please correct screen touch when there's inaccurate touch phenomenon. Icon "+" appears on different location on screen guides you the screen correction. The interface exits after screen touch correction finished, and a message appears to prompt screen touch correction success or failure for your attention.



5.5 Tools Management

Click  on main interface to enter tools management interface.

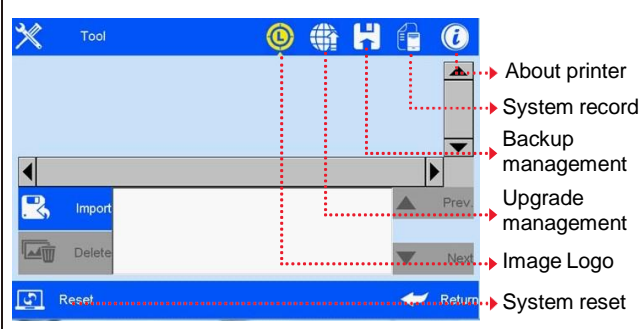

5.5.1 Image Management

Click  to enter image Logo management interface.
 Image import: import image from USB or Ethernet.
 Image format: Solid color BMP;
 Image height: 0-300 pixel point.
 Image length: 0-10000 pixel point.



Note: 1) System prompts and cuts the excess part if the imported image exceeds borders.
 2) Image import cannot be executed when pixel points exceed 100.
 3) Image Logo document route: USB Disk/InkJet/Logo.

5.5.2 System Upgrade



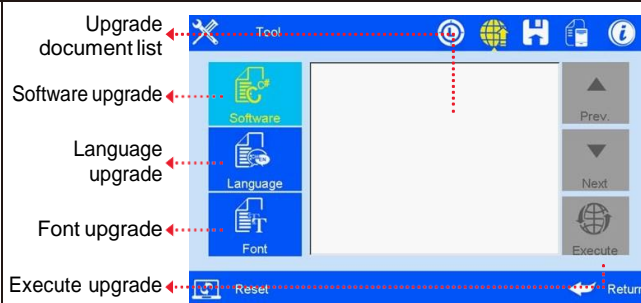

Click  to enter upgrade management interface.
 Users can upgrade the software, add or change languages and fonts by USB.



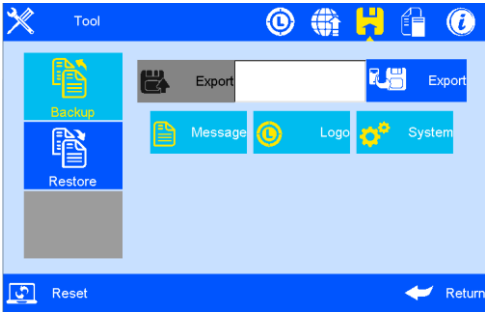

A. Software upgrade	System automatically searches for software upgrade documents in designated folder and displays the upgrade documents by list. User can select anyone in the list for upgrade. Document route: USB Disk/InkJet/Upgrade/Application.
B. Language upgrade	System is loaded with multiple languages upon delivery. User can add one more language if needed. Document route: USB Disk/InkJet/Upgrade/Language.
C. Font upgrade	System supports two fonts; user can add another font besides the default Arial. Document route: USB Disk/InkJet/Upgrade/Font.

Note: Software upgrade documents, language documents, font documents can only be identified when they are packed by the conversion tools provided by our company. The language documents, font documents are not replaceable and cannot be deleted.

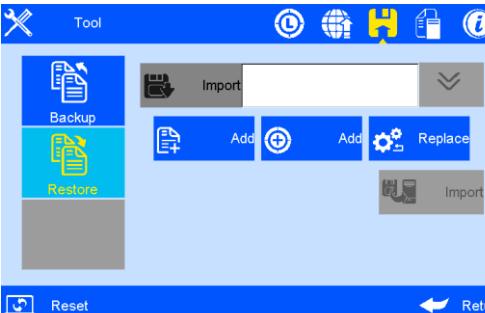

5.5.3 System Backup

<p>Click  to enter backup management.</p> <p>Click  to enter backup operation interface;</p> <p>Export backup: include message, logo and system setting</p>	
<p>Click  to enter the backup restore interface; can restore the message, image and setting of USB disk to the device;</p> <p>Data optional:</p> <ol style="list-style-type: none"> 1、 New: copy the data of USB disk to the device 2、 Replace: replace the same name data 3、 Delete: delete existing data of device 4、 Cancel: Not need to choose data <p>Image optional: new, replace, delete and cancel optional</p> <p>Setting optional: replace and cancel optional</p> <p>Note: Please check USB connection status and disk space is normal when execute backup import and export. Backup document route: USB Disk/InkJet/Backup.</p> <p>export. Backup document route: USB Disk/InkJet/Backup.</p>	



5.5.4 System Record

<p>Click  to enter system record viewing interface. All operation activities including operator, operation and operation time will be shown.</p>	
<p>System record information includes:</p>	<ol style="list-style-type: none"> 1) The printing activities: printing start and stop, initial values. The printing activities: initial values setting diary. 3) All operation activities in system management (including touch screen correction). 4) Image import and delete activities, system upgrade, backup, and reset activities.
<p>Note: System record does not include querying and viewing activities.</p>	

5.5.5 About Equipment

<p>Click  to enter equipment information viewing interface.</p> <p>Information displays current hardware version, software version, machine serial number, dealer code, company Logo, company name and website.</p>	
--	--

5.5.6 System Reset

 Click  on tools management interface to enter system reset management .

Click  to execute system reset. You need to enter administrator password for permission to reset execution.

Message



Are you sure to restore to default settings?

Yes
No

Input

Please enter Administrator password:

OK
Cancel

Note: System reset is to restore all defaults.

- 1) Restore all the settings to defaults, clear all data and images.
- 2) Maintain software version in current version; restore language and font to default.















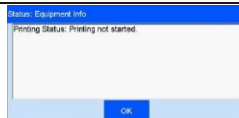



After system reset, system parameters are as follows:

Item #	Item	Parameter
1	Language	English
2	System time	Manufacture time
3	Screen saver time	4 hours
4	Unit	Metric/mm
5	Daylight saving time	OFF
6	Date transition time setting	OFF
7	Pre-zero in date/time	OFF
8	Pre-zero in counter	OFF
9	Counter alarm	OFF
10	Counter reset	OFF
11	Pre-purge	OFF
12	Clean printhead	Standby
13	Printing direction	Left-to-right
14	Channel switch	Left channel
15	Print Recovery	OFF
16	Buffers number	5
17	Line speed	30m/min
18	DPI	300DPI
19	User permission management	OFF
20	Continuous output times	0 OFF
21	Data management	Only system default data Msg001
22	Printing delay	30mm
23	Printing initial value	Counter initial value and data source current value.

5.6 Edit Input Method Options

<p>A keypad appears when user clicks the editing bar. Keypad of Uppercase, lowercase, numeric, or common symbols for changeover.</p>	
<p>A. Uppercase: uppercase keypad is pre-set keypad to appear (see Figure 50).</p>	
<p>B. Lowercase: click Shift to change between uppercase and lowercase.</p>	
<p>C. Numeric and common symbols: Click ?!123 to change between numeric or common symbols input.</p>	
<p>D. More symbols: click Shift on numeric/common symbols keypad for more symbols.</p>	
<p>Shift</p>	<p>Input changeover key</p>
<p>?!123 ABC</p>	<p>Numeric/common symbols and alphabetic input changeover key.</p>
<p>Clean</p>	<p>Remove key (clear all input)</p>
<p>←</p>	<p>Delete (delete one character)</p>
<p></p>	<p>Hide keypad</p>

5.7 Status Bar

	<p>Ink information</p>	<p>Ink information includes dynamic and static information. Static information includes cartridge serial number, client code, cartridge type. Dynamic information: 1) Ink volume, prospect print output for current data. 2) Ink used percentage, remaining prospect print output for current data.</p> <p>Ink status icons include:</p> <p>1) Normal (): Normal ink status.</p> <p>2) warning (): ink amount lower than 10%;</p> <p>3) Error (): wrong cartridge, cartridge not installed, or ink used up.</p>
	<p>Equipment status</p>	<p>Hardware and software status in printer. (e.g. Printing not started)</p> 
	<p>USB information</p>	<p>Automatically displays by icon for equipment normally connected to USB port. Support three devices: USB disk, mouse, and keyboard. Status: not connected (gray), normal connection (green), warning (yellow).</p> <p>Normally connected equipment will be displayed by icon  USB disk,  mouse, or  keyboard.</p>
	<p>Encoder information</p>	<p>Displays encoder or photocell connection status as unconnected (gray) and normally connected (green).</p> <p>When encoder is connected, click  , encoder signal test interface appears.</p> 
	<p>Photocell information</p>	<p>When photocell is connected, click  , photocell signal test interface appears.</p> 
	<p>Ethernet information</p>	<p>The printer connection to computer is realized by Ethernet port, therefore realizes equipment operation and upgrade transmission on PC end. Information includes display IP, mask code, gateway, MAC; can automatic gain or manual input IP, mask code and gateway.</p>  <p>Status includes: Unconnected (gray); Normally connected (green, interaction with PC software normal); Warning (yellow, interaction with PC software wrong, connection failure, software on PC not activated, computer not switched on etc.).</p>
	<p>UV status</p>	<p>When UV LED is connected with printer, UV status will displayed on the screen. UV status including: type, serier number, software version, hardware version, run time.</p> 

	Clean Printhead	Status: Invalid (grey), while printing going on, this function is invalid. Valid (green), can active this function.
---	-----------------	---

Chapter Six: Care and Maintenance

Printer is a precision machine. To keep your machine work properly and bring facilitation to your production; to keep your machine in good condition and extend equipment life, it is important to carry out proper care and maintenance on machine from time to time.

6.1 Printer Care and Maintenance

- 6.1.1 Make sure power cord, power adapter cord, grounding wire is in good condition. Make sure the contact of each cord or wire is reliable.
- 6.1.2 Make sure the screw for grounding wire is secured and the grounding is reliable.
- 6.1.3 Make sure the equipment is not displaced. Make sure the nozzle plate is parallel to printing object, and printing distance is controlled within 0.5-2.5mm. (Please use the designed tools provided by our company to secure the mounting support).
- 6.1.4 Clean ink cartridge: wipe nozzle plate with Non-woven to keep nozzles clean and unclogged. (Please refer to ink cartridge care and maintenance for instructions).
- 6.1.5 Keep touch screen clean. Do not hit touch screen sharply.
- 6.1.6 Keep machine surface and ports clean.
- 6.1.7 Check status bar, make sure equipment icon is normal and there's no alarming status on status bar. (In case of alarm status, check troubleshooting for solution)
- 6.1.8 When machine is turned off, make sure to remove the cartridge from printer, clean the nozzle plate and cap the printhead, and place the cartridge in safe environment. (Please refer to cartridge care and maintenance for instructions).

6.2 Ink Cartridge Care and Maintenance

Maintain correct methods for use and storage of the cartridge will keep the cartridge work with best print quality and extend cartridge life. Please always follow instructions in Ink Cartridge Care and Maintenance. The warranty will not cover damage or failure caused by negligence in following our care and maintenance instructions.

- 6.2.1 Ink volatilizes slowly if the cartridge is decapped. Keep new and undecapped cartridge in its original package. Decap new cartridge only when it is to be used.
- 6.2.2 Try to use up ink as soon as possible once the cartridge is decapped to prevent blockage because ink become dry on nozzle plate very soon.
Note: Due to property difference, different inks have different dry time and care and maintenance methods. Contact our after-sale service for more information.
- 6.2.3 If ink in cartridge is not used up at a time after decapped, remove the cartridge from printer and cap the printhead and store it in airtight container provided by our company. (Storage temperature is room temperature).
Note: Do not use adhesive tape to seal the printhead, and do not store cartridge in soft plastic bag.
- 6.2.4 Nozzle plate is delicate. Do not touch or clean nozzle plate with anything sharp or rough so as not to scratch nozzle plate.
- 6.2.5 Use the Non-woven provided by our company to wipe and clean nozzle plate.
Note: Wipe nozzle plate with the printhead facing down. Move the printhead in the direction of nozzle channel. Move the printhead in the direction across nozzle channel will damage the nozzles.
- 6.2.6 Do not shake ink cartridge or expose it to vibration. Shake or vibration will get air run into cartridge and affect print quality.
To ensure best print quality, contact our company's after-sale service for information of instructions for different inks.

Chapter Seven: Troubleshooting



Note 1: The table below lists the most commonly seen problems and the solutions to each. If there's any other problem, contact your local dealer or our after-sale service for assistance.

Note 2: The table below is for reference only because causes for each problem may differ depending on individual situation such as setup environment, operation demand.

7.1 Troubleshooting for Ink Cartridge

Sr.#	Problem	Problem	Solutions	Comments
1	The print has broken line or white line.	1. Nozzle blockage or damage.	A. See Section 6.2 Ink Cartridge Care and Maintenance, wipe and clean nozzle plate with Non-woven; B. See Section 5.4.3, purge the nozzles by the option "Clean Printhead".	If the problem is still unsolved: Check if there's any spring-loaded connectors depressed in Driver board; Check if there's contamination on cartridge contact plate.
		2. Cartridge not in good contact with printer.	Remove the cartridge and re-insert.	
2	The print is complete at first, and then becomes incomplete	Ink starvation or air bubbles blocking nozzles.	A. Check status bar if there's alarm of low ink. B. Send back to our company for test.	
3	The print is totally blank.	Ink used up or total nozzle blockage.	See Section 5.7 to check ink status: is ink used up?	
4	Unable to identify ink cartridge.	1. Connectivity problem on printer (defect or damage)	Remove cartridge and re-insert.	If problem is unsolved: Check if there's any spring-loaded connectors depressed in driver board. Check if there's contamination on cartridge. Check if there's contamination on ISM card. Check if there's any connector depressed on ISM card board.
		2. Cartridge dealer code mistake.	Remove cartridge and re-insert.	



7.2 Troubleshooting for Printer

Sr.#	Problem	Cause	Solutions	Comment
1	Printer cannot be switched on	1.No power input;	A. Make sure AC power input on adapter is correct, DC output on adapter is well connected with printer. B. Check if power adapter light is normal. Replace a new adapter if light is dead, dim or blinking.	
		2. Printer switch not turned on.	Make sure the printer power switch is turned ON.	
		3. Equipment damage.	Contact local dealer or after-sale service.	
2	Printer does not print	1. Printing not started.	Pls check firstly if the current status is in printing.	
		2. No data for printing.	Select a file and click "Start printing" button.	
		3. Printing delay value too big.	Check if the printing delay value is normal.	
		4. Cartridge not installed.	Install a cartridge.	
		5. Cartridge installed but used up or damaged.	Check cartridge status according to Section 5.7, is ink used up or cartridge dealer code wrong?	If ink used up, or cartridge dealer code wrong, replace a new cartridge.
		6. Photocell not works.	Cover up the photocell to check according to 5.2.2 to see if there's variation in print output quantity in printing report.	When the external equipment is photocell, click  for photocell signal test interface, test if photocell works.
		7. Encoder is connected but damaged.	Check if the encoder and its connection wire are in good condition; check if the production line is running well.	When the external equipment is encoder, click  for encoder signal test interface, move encoder to check if the encoder works.

Appendix 1: Terms and Definitions

Sr.#	Term	Definition	Comment
1	Printing delay	It is the distance from the point when photocell senses the printing object to the point when printing starts. User can adjust the value to alter the print position on printing object.	E.g. Printing delay value is 30mm, printer starts printing at 30mm point after the photocell senses the printing object.
2	Printing initial value	It is beginning value in printing process for print data.	E.g. Set the initial value as 9, the counter counting starts from 9 for first print.
3	Screen saver time	It is a power saving function, the screen will automatically turn off and enter standby mode when the screen is inactive for a time period as set.	E.g. Set the screen saver time as one minute. The screen will automatically turn off and enter standby mode if the screen becomes inactive for one minute.
4	Customer year	It is the special year on customer demand. Customer can change the year in date format by any round number within scope.	E.g. The system date is 2012/07/31. Supposed the date by customer is 2010/07/31, customer can set the year in date as 2010. Then the date shown on the print will be 2010/07/31.
5	Date transition time setting	When system time reaches certain point, the printout date and time will be that of the next date.	For example: Current date is 07.10, set the date transition time to be 07:59, then the time of last printing out before that is recorded as 09/07 07:59, after that is 10/07,8:00. If the date transition time is 12:01, then the time of last printing out before that is recorded as 10/07 12:00, after that is 11/07.
6	Pre-purge	Ink becomes dry on nozzle plate during use. The dried ink will make the print not clear for half of first character. To prevent this phenomenon, user can turn this function ON.	When Pre-purge function is turned ON, printer will spray a little ink at optioned level during idle period in printing process to keep nozzle plate warm and moist so as to eliminate dried ink phenomenon.
7	Clean Printhead	Customer can use this function to purge nozzles.	Purge whole nozzle plate, make sure nozzles are unblocked.
8	Channel switch	Customer can switch for different channel to achieve best print quality according to print need and nozzle channel condition.	E.g. At option of single-channel printing, when there are damage in left channel nozzle or there are missing dots in print by left channel, user can switch to right channel printing. At option of dual-channel printing, left channel and right channel will work at same time for printing to achieve darker print and best print quality.
9	Continuous printing	Multiple outputs of same print during one session of period photocell sensing the print object.	
10	Printing Recovery	When there is a power failure, and the setting is "ON", system will go back to the last printing status and resume printing when power gets back. The default setting for this function is "OFF"	When the printing contains counter, and the Printing Recovery setting is "ON", operator need to check on the counter value and do needful adjustment.

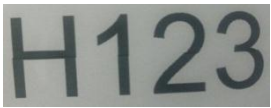
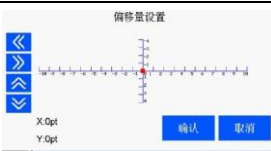
Appendix 2: Offset Adjustment Example

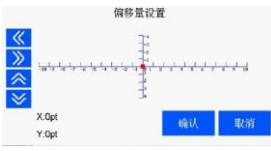
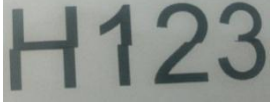
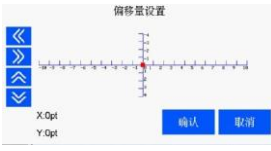
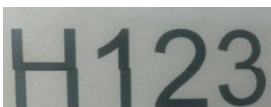
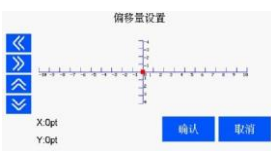
Problem	Printing	Offset Adjustment	After Adjustment
X-axis align Y-axis overlay			
	Adjust downward, scope(Y-axis: -4~4)		
X-axis align Y-axis separate			
	Adjust upward, scope (Y-axis: -4~4)		
X-axis left dislocation Y-axis align			
	Adjust to right, scope (X-axis: -10~10)		
X-axis right dislocation Y- axis align			
	Adjust to left, scope (X-axis: -10~10)		
<p>Note: 1、 Adjust scope varies in different case, unit: dot; 2、 If mismatch remain after adjustment, please check if the printheads is installed vertically with the production line.</p>			

High Resolution Inkjet Printer